

KETTLER



Cora Lounge Armchair

HUC23433



IMPORTANT

PLEASE KEEP THIS BOOKLET FOR FUTURE REFERENCE.
THIS IS IMPORTANT INFORMATION REGARDING THE
USE AND CARE OF YOUR GARDEN FURNITURE.









ASSEMBLY
TIME

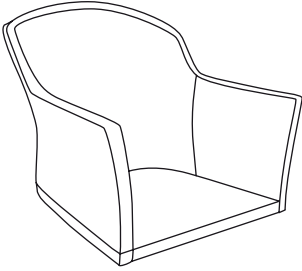

PERSONS
REQUIRED

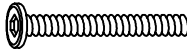
Parts List

<p>(A) Front Left Leg</p>  <p>x1</p>	<p>(B) Back Left Leg</p>  <p>x1</p>	<p>(E) Chair Body</p>  <p>x1</p>
<p>(C) Back Right Leg</p>  <p>x1</p>	<p>(D) Front Right Leg</p>  <p>x1</p>	
<p>(F) Screw M6x45 (mm)</p>  <p>x8</p>	<p>(G) M6x19x2 (mm)</p>  <p>x8</p>	<p>(H) Allen Key 4</p>  <p>x1</p>



Do not discard any of the packaging until you have checked that you have all the parts and the pack of fixings.

Helpful advice before you begin:

1. We suggest you spend a short time reading through this leaflet and then follow the simple step by step instructions.
2. Do not discard any of the packaging until you have checked that you have all the parts and the pack of fittings.
3. Assemble this product on a soft surface.
4. To ensure an easier assembly, we strongly advise that all fittings are only finger tightened during initial assembly. Only upon completion of the assembly should all fixing points be fully tightened.
5. Keep fittings out of children's reach.
6. Do not use any other tools other than those recommended to build this product.
7. Please do not use substitute parts. Use only additional or replacement parts supplied by Kettler.
8. In the unlikely event that this product has missing or damaged parts, please visit our website www.kettler.co.uk

Assembly

1

Ensure the chair is protected during assembly to avoid damage to the surface

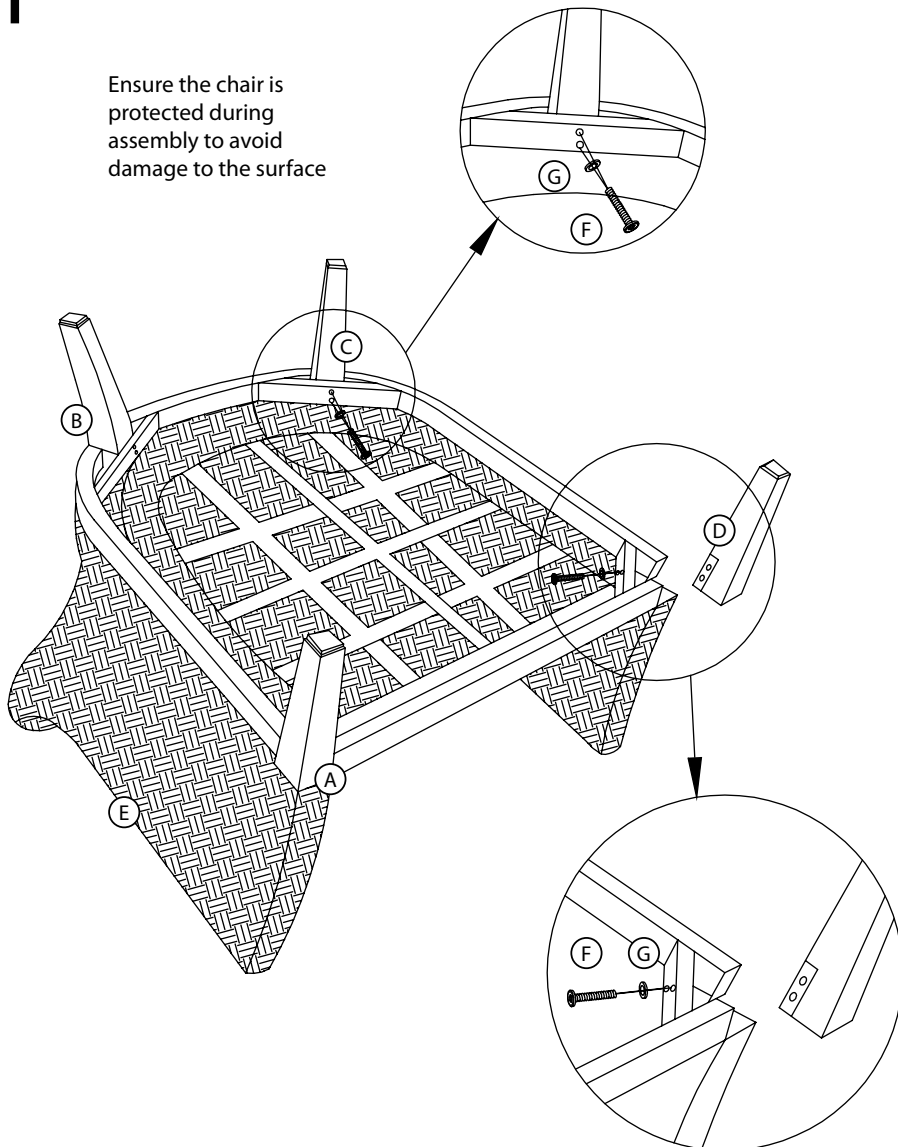

Assembly

3

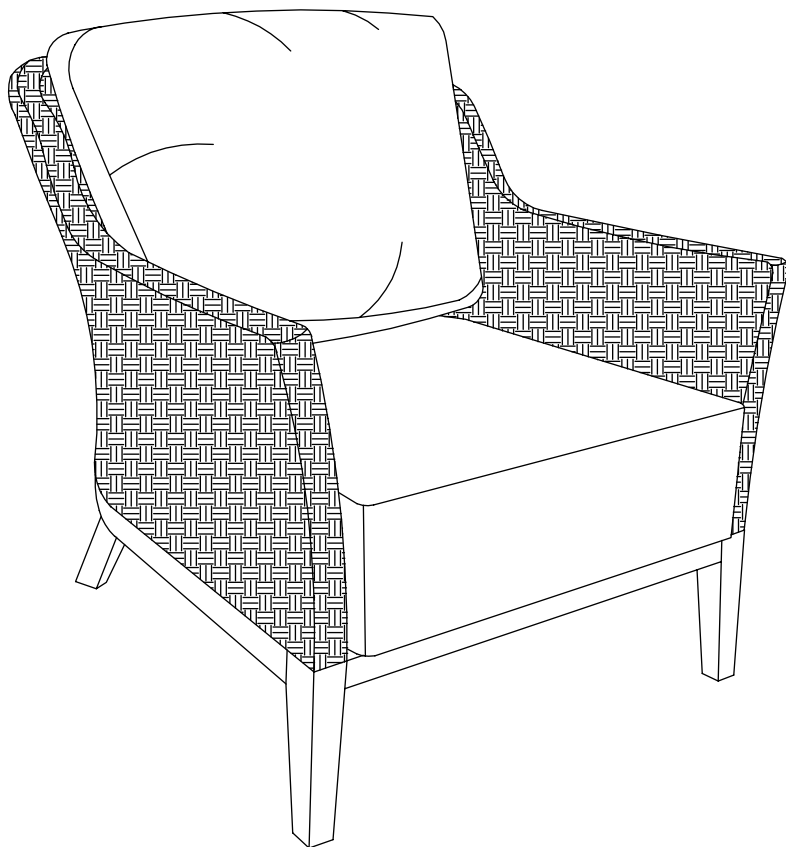

Finished

Maintenance and Care Instructions

- This product may only be used for its intended purpose for residential premises. Any other uses may affect the warranty.
- Acacia wood requires regular cleaning and maintenance. Remove dust regularly with a clean soft brush and wipe down with a clean damp cloth. Use pads, mats and coasters under plates, glasses cups etc to protect them from scratches, spills, stains and heat damage. Wipe spills immediately to prevent staining.
- Storage: During Winter/wetter months store in a cool, dry and well ventilated location to prevent excessive shrinkage or expansion of the wood. Alternatively cover the furniture with a Kettler tailored cover or use a universal breathable cover.
- Moving parts such as locking mechanisms, catches and joints need to be lubricated where necessary.
- Simply wash with mild soapy water using a soft and clean cloth. Then rinse the furniture and dry with a soft clean cloth. We would advise applying Kettler hardwood shield (available to buy from our website) 2-3 times per year (table tops) and 1-2 times per year for chairs.
- Cushion care - Kettler cushions are not suitable for dry cleaning and not machine washable. They are sponge clean only. Why not consider our "Fabric care kit" from our website for both cleaning and protecting your cushions.
- Kettler furniture can be covered - we recommend that you only use Kettler tailored covers. (where available) or a universal breathable cover.
- This product is 100% recyclable. At the end of the products life, please dispose of responsibly.
- Colours may vary slightly.



Attention

Please be aware that painted/varnished surfaces can be damaged by sunscreens. If the surface of your Kettler leisure furniture comes into contact with sunscreens, the surface is to be cleaned without delay as described above. Only in this way can lasting discolouration of the surface by the ingredients of the sunscreen be prevented.

For Your Safety

- Check all components regularly for correct function, damage and loose connections especially at the start of the season and at 1-2 month intervals dependent on use.
- Damaged components may endanger your safety or shorten the life of the product. Replace all damaged parts immediately. Use only spare parts manufactured by Kettler. Should you wish to purchase spare parts, they can be ordered directly from: www.kettler.co.uk/shop
- Kettler will not be responsible for damaged caused by improper use.



Attention

- Whilst assembling this product keep out of the reach of children. (Choking hazard – contains small parts)
- Ensure that your working area is free of possible sources of danger, for example don't leave any tools lying around.
- Always dispose of packaging material in such a way that it may not cause any danger. There is always a risk of suffocation if children play with plastic bags!
- We reserve the right to make changes for technical reasons.

KETTLER



www.kettler.co.uk



Warranty For Home Use

This product is covered by a 3 year warranty against manufacturing faults. This warranty applies to domestic use only. It does not cover commercial use, mis-use or accidental damage.

To validate your warranty, register at www.kettler.co.uk and quote the product code from the front of this booklet.