

KETTLER

Henley Mesh Table









08309/03807/08310/03809/08313

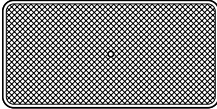
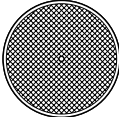

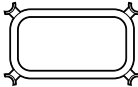
IMPORTANT

PLEASE KEEP THIS BOOKLET FOR FUTURE REFERENCE.
THIS IS IMPORTANT INFORMATION REGARDING THE USE AND
CARE OF YOUR GARDEN FURNITURE.

Parts List

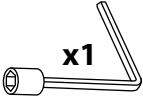
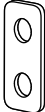
(A) Table Top - You will have x1 of the following:  x1 or  x1			 Do not discard any of the packaging until you have checked that you have all the parts and the pack of fixings.
(B) Leg Connecting Frame - You will have x1 of the following:  x1 or  x1			
(C) Screws M6x20  x8	(D) Washers  x12	(E) M6 Nuts  x4	(I) Table Legs  x4
(F) Hex Plastic Caps  x4	(G) Hex Socket Allen Key  x1	(H) Plastic Washer  x4	

Helpful advice before you begin:

1. We suggest you spend a short time reading through this leaflet and then follow the simple step by step instructions.
2. Do not discard any of the packaging until you have checked that you have all the parts and the pack of fittings.
3. Assemble this product on a soft surface.
4. To ensure an easier assembly, we strongly advise that all fittings are only finger tightened during initial assembly. Only upon completion of the assembly should all fixing points be fully tightened.
5. Keep fittings out of children's reach.
6. Do not use any other tools other than those recommended to build this product.
7. Please do not use substitute parts. Use only additional or replacement parts supplied by Kettler.
8. In the unlikely event that this product has missing or damaged parts, please visit our website www.kettler.co.uk

Assembly

Overview



Ensure the table top is protected during assembly to avoid damage to the surface



Assemble all parts loosely and when all components are in place tighten fixings to secure

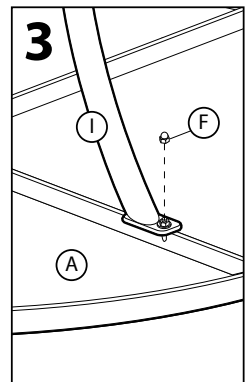
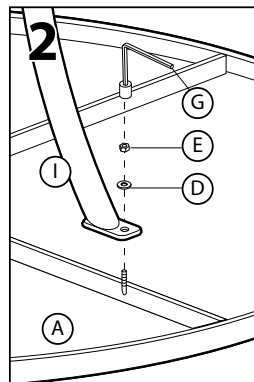
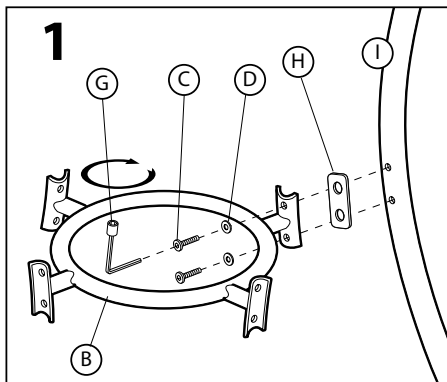
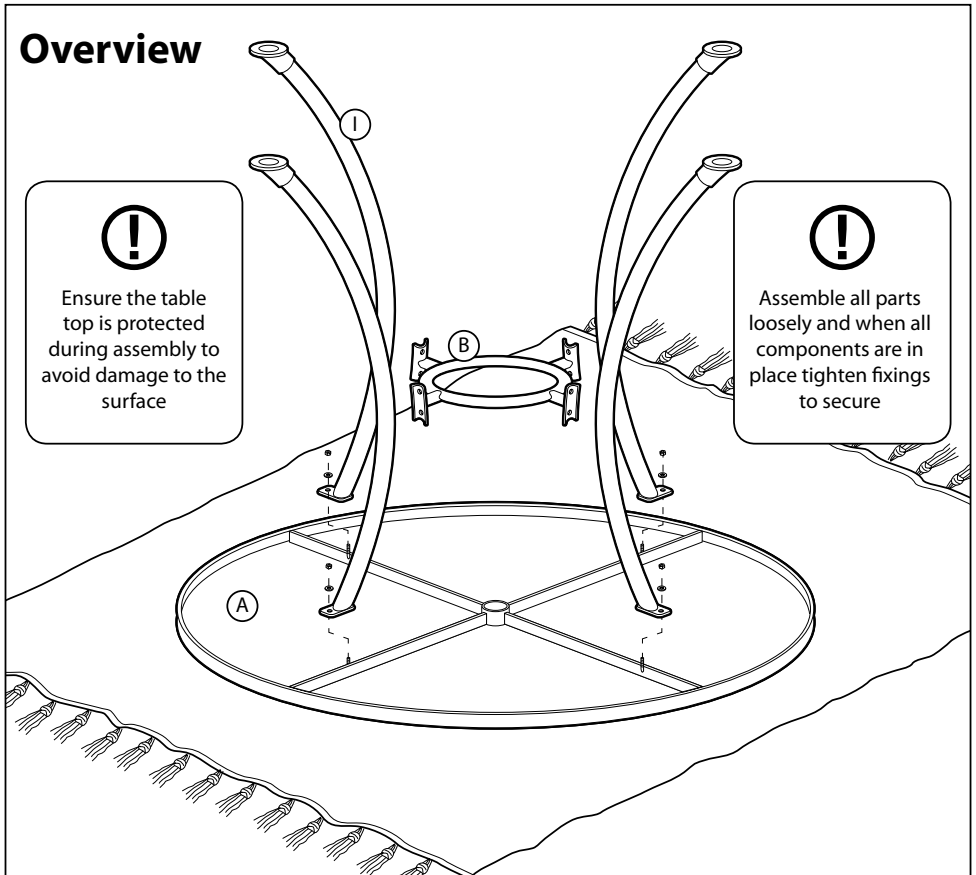

For Your Safety

- This product may only be used for its intended purpose as furniture for residential properties.
- Check all components regularly for correct function, damage and loose connections especially at the start of the season and at 1-2 month intervals dependent on use.
- Damaged components may endanger your safety or shorten the life of the product. Replace all damaged parts immediately. Use only spare parts manufactured by Kettler. Should you wish to purchase spare parts, they can be ordered directly from: www.kettler.co.uk/shop
- Kettler will not be responsible for damaged caused by improper use.



Attention

- Whilst assembling this product keep out of the reach of children. (Choking hazard – contains small parts)
- Ensure that your working area is free of possible sources of danger, for example don't leave any tools lying around.
- Always dispose of packaging material in such a way that it may not cause any danger. There is always a risk of suffocation if children play with plastic bags!
- We reserve the right to make changes for technical reasons.

KETTLER

Kettler GB Limited,
Merse Road, North Moons Moat,
Redditch, Worcestershire,
B98 9HL



www.kettler.co.uk



Warranty For Home Use

KETTLER furniture is covered by a 5 YEAR ANTI RUST WARRANTY against rust causing failure.

The warranty applies to domestic use only. If the product is damaged or chipped, rust may occur, and will not be covered by this warranty. If a product is accidentally damaged you can obtain touch up paint from our website www.kettler.co.uk

No warranty claims can be accepted without a valid proof of purchase.