

RHS

BY

KETTLER

5ft Bench

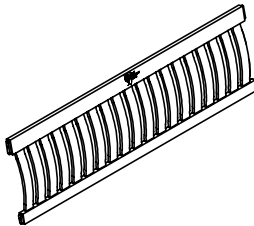
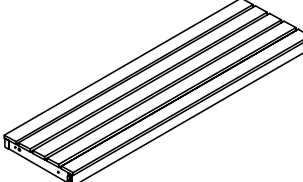
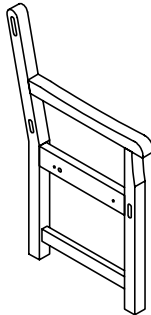
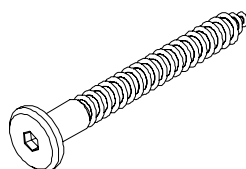
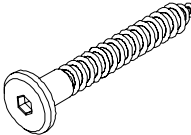
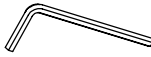

Parts List

<p>(A) Back Assembly</p>  <p>x1</p>	<p>(B) Seat Assembly</p>  <p>x1</p>	<p>(C) Side Frames</p>  <p>x2 (L&R)</p>
<p>(D) Screw (M7 x 90)</p>  <p>x6</p>	<p>(E) Screw (M6 x 40)</p>  <p>x4</p>	<p>(F) Allen Key</p>  <p>x2</p>

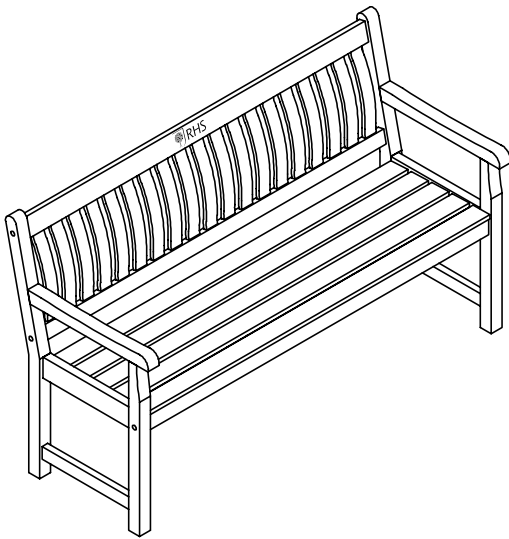

Do not discard any of the packaging until you have checked that you have all the parts and the pack of fixings.

Helpful advice before you begin:

1. We suggest you spend a short time reading through this leaflet and then follow the simple step by step instructions.
2. Do not discard any of the packaging until you have checked that you have all the parts and the pack of fittings.
3. Assemble this product on a soft surface.
4. To ensure an easier assembly, we strongly advise that all fittings are only finger tightened during initial assembly. Only upon completion of the assembly should all fixing points be fully tightened.
5. We recommend a periodic check on all fixing points to make sure they remain fully tightened.
6. Keep fittings out of children's reach.
7. Do not use any other tools other than those recommended to build this product.
8. Please do not use substitute parts. Use only additional or replacement parts supplied by Kettler.
9. In the unlikely event that this product has missing or damaged parts, please visit our website www.kettler.co.uk.

Assembly Instructions

1

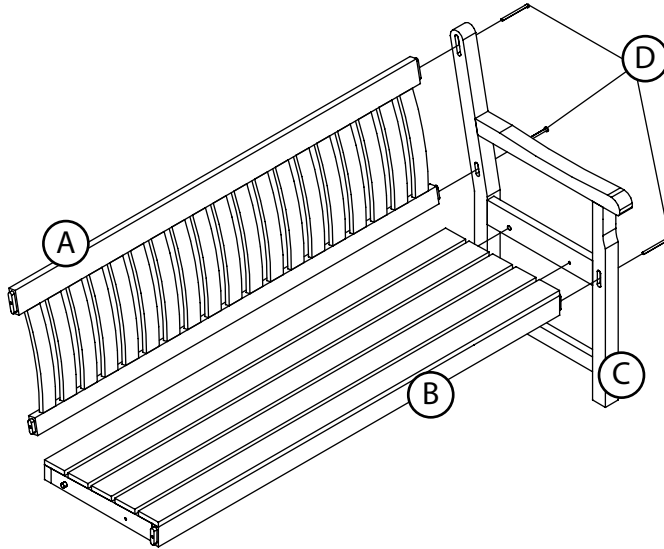

Ensure the bench is protected during assembly to avoid damage to the surface

2

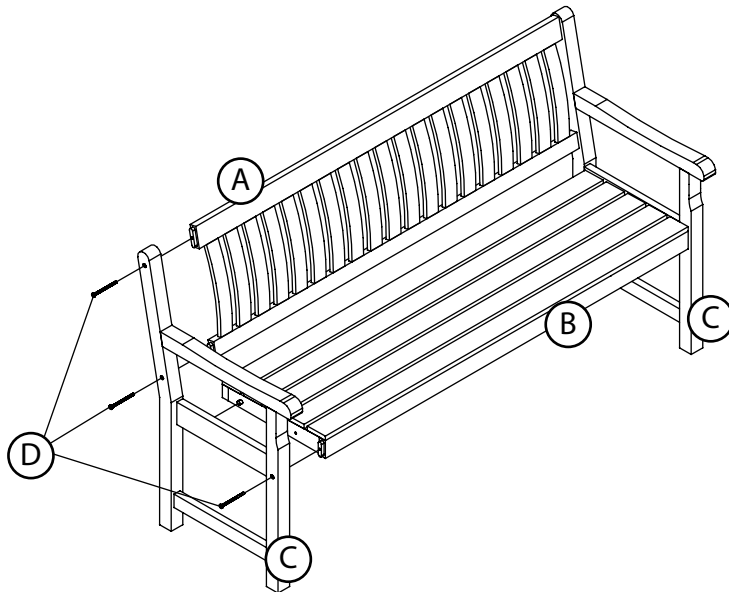

3

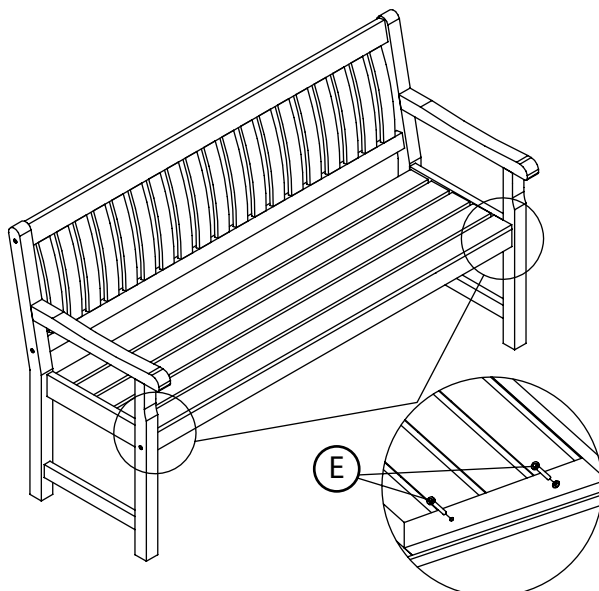

Assemble all parts loosely and when all components are in place tighten fixings to secure

For your safety

- This product may only be used for its intended purpose for residential premises. Any other uses may affect the warranty.
- Cushions are available for this range. They need to be stored away in a dry environment when not in use. They are sponge clean only.
- Wood is a natural material which reacts to weather conditions. Depending on weather type, the wood can swell or dry resulting in small cracks. The risk can be minimised by cleaning and/or treating the furniture at regular intervals and keeping it clean and dry.
- Remove dust regularly with a clean, soft brush and wipe down with a clean damp cloth. Use pads, mats and coasters under plates, glasses cups etc to protect them from scratches, spills, stains and heat damage. Wipe spills immediately to prevent staining.

We recommend the following cleaning regime using Kettler wood aftercare treatment to keep the furniture maintained and looking its best:

Kettler Hardwood Cleaner - during the Spring (once a year). First moisten the wood with water. Apply the HARDWOOD CLEANER with a soft cloth or sponge. Allow to soak for 3 minutes. Brush the furniture clean with a scrubbing pad in the direction of the grain. Rinse furniture well with water.

Kettler Hardwood Colour Protector - during the Spring (once a year). Use the Instant Protector (Brown) for the Chelsea range. Apply a thin layer of the protector with a soft cloth. Allow to dry for 1 hour and then the wood has turned brown. (If you wish to have a more intense colour, apply a second thin layer).

Kettler Hardwood Shield - Spring and Autumn (2-3 times a year). Make sure the Hardwood is 100% dry and free of dust. Apply a thin layer of HARDWOOD SHIELD with a soft cloth. Allow to dry for one hour and then apply a second thin coat of HARDWOOD SHIELD. Let the wood dry for 48 hours before exposure to moisture and rain.

Care products are available to buy from www.kettler.co.uk

Storage: During Winter/wetter months store in a cool, dry and well-ventilated location to prevent excessive shrinkage or expansion of the wood. Alternatively cover the furniture with a Kettler tailored cover (where available) or use a universal breathable cover.

- Moving parts such as locking mechanisms, catches and joints need to be checked/lubricated where necessary.
- This product is 100% recyclable. At the end of the products life, please dispose of responsibly.
- Colours may vary slightly.

⚠ Attention

- Whilst assembling this product keep out of the reach of children. (Choking hazard – contains small parts)
- Ensure that your working area is free of possible sources of danger, for example don't leave any tools lying around.
- Always dispose of packaging material in such a way that it may not cause any danger. There is always a risk of suffocation if children play with plastic bags!
- We reserve the right to make changes for technical reasons.

Please keep these assembly instructions for any spare parts orders

KETTLER

www.kettler.co.uk



Warranty For Home Use

For manufacturing faults only.

The warranty applies to domestic use only. If the product is damaged through accidental damage or mis-use, your warranty will be void. Spare parts and touch up paints can be obtained from our website.

To validate your warranty, register at www.kettler.co.uk and quote the product code from the front of this booklet.