

# KETTLER

## LaMode 2 Seater Sofa





0296813-3009

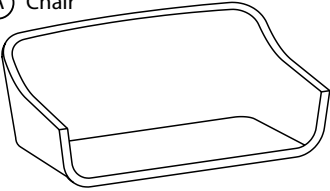
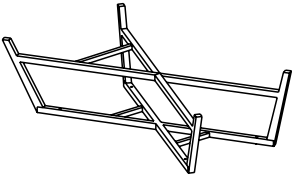
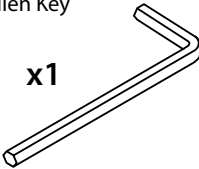

**IMPORTANT**

PLEASE KEEP THIS BOOKLET FOR FUTURE REFERENCE.  
THIS IS IMPORTANT INFORMATION REGARDING THE USE AND  
CARE OF YOUR GARDEN FURNITURE.

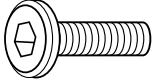
# Parts List

<p>(A) Chair</p>  <p>x1</p>	<p>(B) Leg Frame</p>  <p>x1</p>	
<p>(C) Allen Key</p>  <p>x1</p>	<p>(D) Plastic Caps</p>  <p>x4</p>	<p>(E) Screws M6x40</p>  <p>x4</p>
<p>(F) M6 Steel Washers</p>  <p>x4</p>	<p></p> <p>Do not discard any of the packaging until you have checked that you have all the parts and the pack of fixings.</p>	

## Helpful advice before you begin:

1. We suggest you spend a short time reading through this leaflet and then follow the simple step by step instructions.
2. Do not discard any of the packaging until you have checked that you have all the parts and the pack of fittings.
3. Assemble this product on a soft surface.
4. To ensure an easier assembly, we strongly advise that all fittings are only finger tightened during initial assembly. Only upon completion of the assembly should all fixing points be fully tightened.
5. We recommend a periodic check on all fixing points to make sure they remain fully tightened.
6. Keep fittings out of children's reach.
7. Do not use any other tools other than those recommended to build this product.
8. Please do not use substitute parts. Use only additional or replacement parts supplied by Kettler.
9. In the unlikely event that this product has missing or damaged parts, please visit our website [www.kettler.co.uk/shop](http://www.kettler.co.uk/shop).

# Assembly

1



Ensure the table top is protected during assembly to avoid damage to the surface

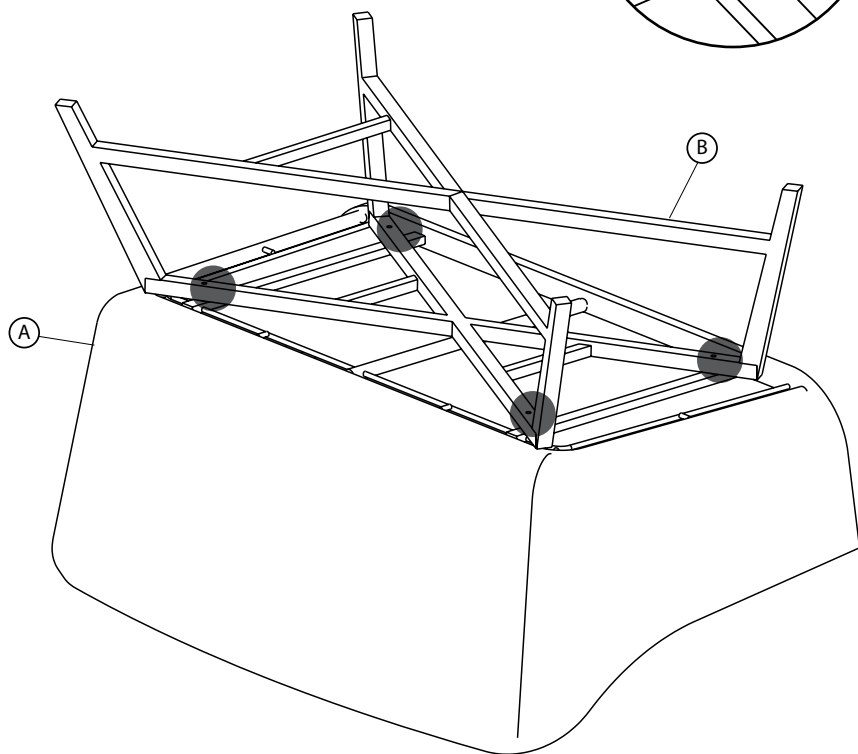
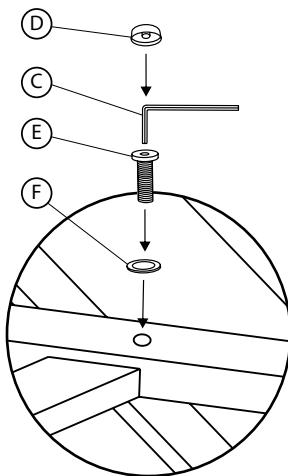

# Assembly

2

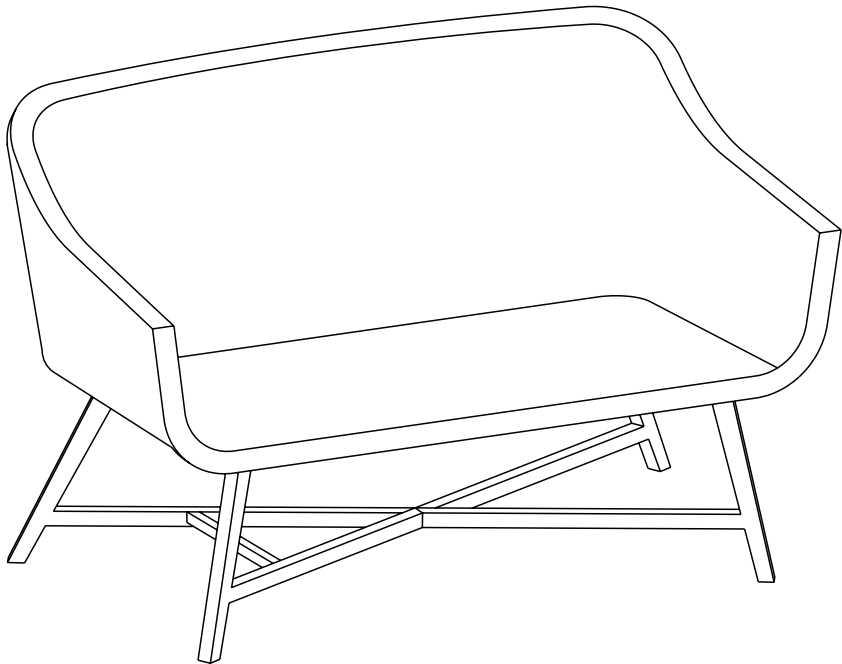

Assemble all parts  
loosely and when all  
components are in place  
tighten fixings to secure

# Maintenance and Care Instructions

- This product may only be used for its intended purpose for residential premises.
- Kettler furniture is designed to be left outdoor all year round (excluding cushions).
- Moving parts such as locking mechanisms, catches and joints need to be lubricated where necessary.
- We recommend you clean your Kettler furniture at the beginning and end of the season. To clean your Kettler furniture, use warm soapy water only. Never use abrasive chemicals or cleaning agents. Tree sap and bird droppings should be cleaned off immediately.
- Kettler cushions are not suitable for dry cleaning and are not machine washable. Sponge clean only.
- Kettler furniture can be covered – we recommend that you only use Kettler tailored covers.
- This product is 100% recyclable. At the end of the products life, please dispose of responsibly.
- Colours may vary slightly.



## Attention

Please be aware that painted/varnished surfaces can be damaged by sunscreens. If the surface of your Kettler leisure furniture comes into contact with sunscreens, the surface is to be cleaned without delay as described above. Only in this way can lasting discolouration of the surface by the ingredients of the sunscreen be prevented.

# Spare Parts

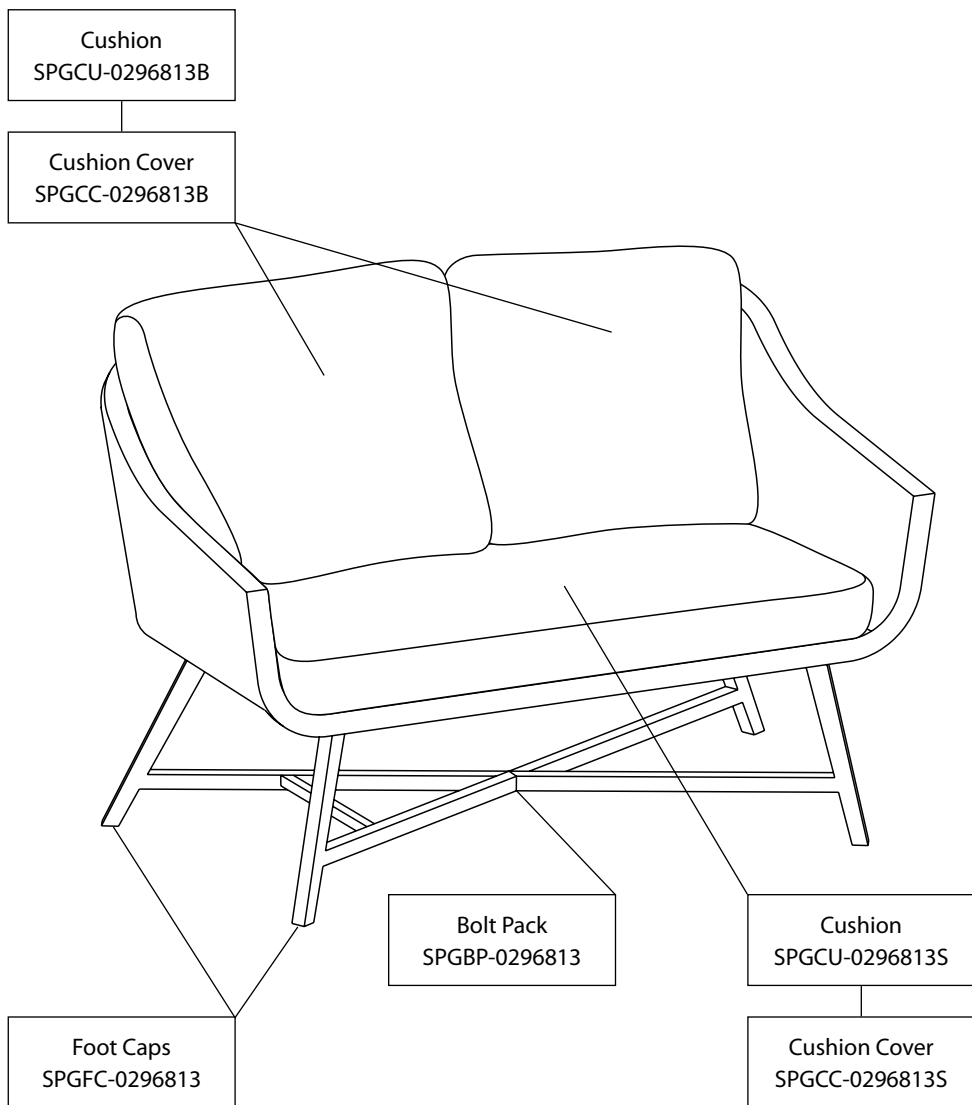

For further information and spare parts visit our website [www.kettler.co.uk/shop](http://www.kettler.co.uk/shop)

# Warranty



## **Warranty For Home Use**

This product is covered by a 3 year warranty against manufacturing faults. This warranty applies to domestic use only. It does not cover commercial use, mis-use or accidental damage.

Warranty claims cannot be accepted without a proof of purchase.

**[www.kettler.co.uk](http://www.kettler.co.uk)**

# For Your Safety

- This product may only be used for its intended purpose as furniture for residential properties.
- Check all components regularly for correct function, damage and loose connections especially at the start of the season and at 1-2 month intervals dependent on use.
- Damaged components may endanger your safety or shorten the life of the product. Replace all damaged parts immediately. Use only spare parts manufactured by Kettler. Should you wish to purchase spare parts, they can be ordered directly from: [www.kettler.co.uk/shop](http://www.kettler.co.uk/shop)
- Kettler will not be responsible for damaged caused by improper use.



## Attention

- Whilst assembling this product keep out of the reach of children. (Choking hazard – contains small parts)
- Ensure that your working area is free of possible sources of danger, for example don't leave any tools lying around.
- Always dispose of packaging material in such a way that it may not cause any danger. There is always a risk of suffocation if children play with plastic bags!
- We reserve the right to make changes for technical reasons.

# KETTLER

Kettler GB Limited,  
Merse Road, North Moons Moat,  
Redditch, Worcestershire,  
B98 9HL



[www.kettler.co.uk](http://www.kettler.co.uk)