

KALOS

ADDING WARMTH TO OUTDOOR LIVING

Ibiza Electric Floor Standing - 1800W

with LED & Wireless Speaker

KLEH160-0600

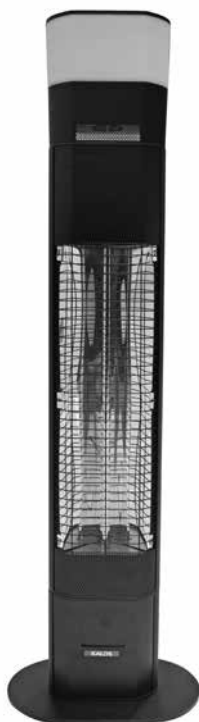

IMPORTANT

PLEASE KEEP THIS BOOKLET FOR FUTURE REFERENCE.
THIS IS IMPORTANT INFORMATION REGARDING THE USE AND
CARE OF YOUR OUTDOOR HEATER.







ASSEMBLY
TIME



PERSONS
REQUIRED

Important Information

-  Unpack the outdoor heater making sure that all of the items are present and that there are no components left in the box and the heater head is free from any packaging material. Extra packaging is added to some models for transportation protection which must be removed before assembly.
-  Using the detailed drawing following the steps to assemble the outdoor heater (where relevant).
-  **DO NOT** connect the outdoor heater to the electrical supply until the assembly is complete.
-  **DO NOT** connect the outdoor heater to the electrical supply if any of the components or power cord is damaged in any way.
-  **CAUTION** - Risk of Electric Shock. **DO NOT** open or try to repair the heater yourself.

Important advice before you begin:

This appliance is not intended for use by persons (including children) with reduced physical, sensory or mental capabilities or lack of experience and knowledge if they have been given supervision or instruction concerning use of the appliance in a safe way and understand the hazards involved.

Children should not play with the appliance.

Cleaning and user maintenance should not be made by children without supervision.

Do not use any other tools other than those recommended to build this product.

Please do not use substitute parts. Use only additional or replacement parts supplied by Kettler.

In the unlikely event that this product has missing or damaged parts, please visit our website www.kettler.co.uk/shop.

For Your Safety

Warning

- This heater is not equipped with a device to control the room temperature. **DO NOT** use this heater in small rooms when they are occupied by persons not capable of leaving the room on their own, unless constant supervision is provided.
- Children of less than 3 years should be kept away unless continuously supervised.
- Children under 8 years shall not plug in, regulate and clean the appliance or perform user maintenance.



Caution

- Some parts of this product can become very hot and cause burns. Particular attention must be given where children, vulnerable people and animals are present.
- **For floor mounted heaters only** use the heater on a firm solid horizontal area where all the feet on the base are in contact with the floor. (Should the heater be tilted or fall over the auto cut off switch will activate).
- Risk of Electric Shock. **DO NOT** open or try to repair the heater yourself.
- Any maintenance or repairs including replacing the tube(s) should only be carried out by a qualified electrician or by a qualified service centre.

1. Site the heater outside or in a large open area and well away from any obstructions such as branches or where the heater is near any objects that can be affected by heat, such as furniture, curtains or other inflammable objects (minimum distance 1 metre).
2. **DO NOT** use this heater in the immediate surroundings of a bath, a shower or a swimming pool. Do not use near water.
3. **DO NOT** use in unventilated areas.
4. **DO NOT** use where gas, petrol, paint or other surely flammable goods are stored.
5. **DO NOT** push any items through, obstruct or cover the grill of the heater head.
6. **DO NOT** position immediately above or below an electrical socket.
7. **DO NOT** move when connected to an electrical supply and always wait for the patio heater to cool down before cleaning / storing away.
8. **DO NOT** touch the heater head when in use.
9. **DO NOT** leave turned on and unattended especially when children and or animals are in the vicinity.
10. The indication of the different positions of switches shall be visible from a distance of 1M.

For Your Safety

11. The marking concerning covering should be visible after the heater has been installed. It shall not be placed on the back of portable heaters.
12. The unit must be placed with the clearance of 100cm to the wall and 30cm to the ceiling.
13. The unit must be correctly installed according to the instructions.
14. The unit is at high temperature during operation. It keeps hot for a period after shut down. Potential danger would occur when touching it during this period. Unplug the unit and wait till it cools before cleaning.
15. **DO NOT** place the unit close to curtain and/or other flammable objects. Otherwise there will be a danger of catching fire.
16. **DO NOT** cover the unit with anything during operation or a short time after it is shut down.
17. **DO NOT** wrap the power supply cord on the unit.
18. The unit must be handled with care, and avoid vibration or hitting.
19. An apparatus with CLASS I construction shall be connected to a MAINS socket outlet with a protective earthing connection.
20. **DO NOT** use if the unit or power cable is damaged.
21. **DO NOT** attempt to repair or adjust any electrical or mechanical functions on this unit. Doing so will void your warranty. The inside of the unit contains no user serviceable parts. Servicing / Repair should only be performed by a qualified electrician or qualified service centre.
22. **DO NOT** use this unit in place where causticity or volatile air exists, i.e. dust, steam, gas, etc.
23. **DO NOT** use this unit as a cloth drier or towel drier.
24. **DO NOT** use this unit as a sauna heater.
25. **DO NOT** use this unit as a room heater.
26. **DO NOT** use this unit in place of animal propagating and raising.
27. **DO NOT** immerse this unit into water for cleaning.
28. The unit should be plugged in a socket, which is easily visible and reachable.
29. **DO NOT** use this heater with a programmer, timer or any other device that switches the heater on automatically, since a fire risk exists if the heater is covered or positioned incorrectly.
30. Children should be supervised to ensure that they do not play with the appliance.
31. When assembling, keep clear from any board or flammable material.

For Your Safety

- 32. DO NOT** insert or allow foreign objects to enter any ventilation or exhaust opening as this may cause an electric shock or fire, or damage the heater.
- 33.** Use only for intended household use as described in this manual. Any other use not recommended by the manufacturer may cause fire, electric shock, or injury to persons. The use of attachments not recommended or sold by unauthorized dealers may cause hazards.
- 34.** The unit is for household use only. It is not safe to use on a building site, greenhouse, barn or stable where there's flammable dust.
- 35.** Avoid the use of an extension cord because the extension cord may overheat and cause a risk of fire. However, if you must use an extension cord, the cord shall be rated to 13A (Minimum conductor size 1.5mm²) and if the cord is on a reel it must be fully unwound before use.
- 36.** Disconnect the power cable from the electrical supply when the heater is not in use. If the power cord becomes damaged, it must be replaced by a qualified electrician.
- 37.** This appliance is not intended for use by a person (including children) with reduced physical, sensory or mental capabilities, or lack of experience and knowledge, unless they have been given supervision or instruction concerning use of the appliance by a person responsible for their safety.
- 38.** One dark point may exist on the surface of the heating elements during the first few minutes after it is turned on. This is normal, and will not affect the performance of the unit.
- 39.** To avoid fire or shock hazard, plug the unit directly into a 220-240 Vac and 13A electrical socket outlet.

Assembly

1

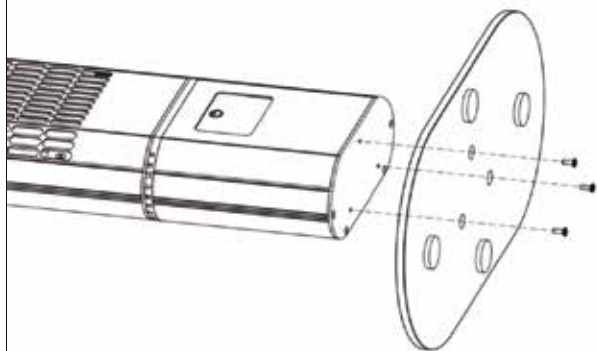

- **Step 1:** Fix the Heater Pole on the base by using the provided 3PCS of M4 *14mm screws.

2

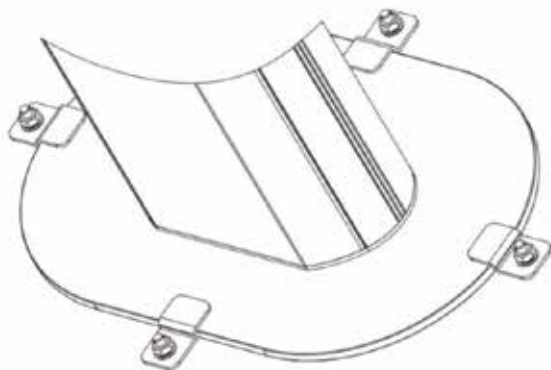

- **Step 2:** Fix the product to the floor with screws.

Finished

Operation Instructions

The switch on the heater is used to control the Heating and light and speaker, the left position for LED light and Wireless speaker, the right position for heater.

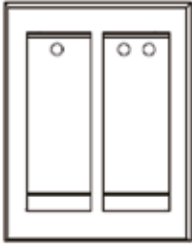

Touch “☺” on the panel once, it’s 1800W for the heating element below

Touch “☺” on the panel twice, turn off the heater.



WARNING: The heater must be properly installed before it is used.
This unit is equipped with one heat setting On I Off.



WARNING! Please remove the PE bag before using! Please take down the insulation sheet before use the Remote Control. The battery model of Remote Control is Lithium Cell CR2025



WARNING! Do not ingest the battery, Chemical Burn Hazard. This product contains a coin/button cell battery. If the coin/button cell battery is swallowed, it can cause severe internal burns in just 2 hours and can lead to death.

Keep new and used batteries away from children. If the battery compartment does not close securely, stop using the product and keep it away from children.

If you think batteries might have been swallowed or placed inside any part of the body, seek immediate medical attention.

Operation Instructions

The Remote Control

Press the "ON", the heater will be 1800W;

Press the "OFF", the heater will be turned off.

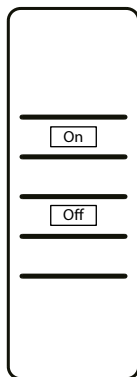

LED light remote control instructions

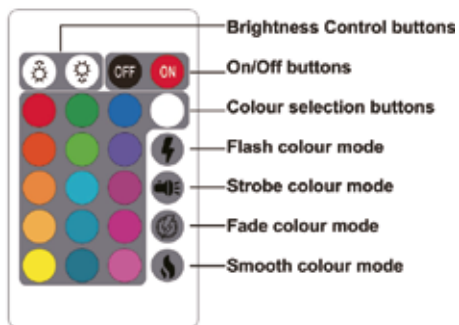

Trouble Shooting

If the heater will not operate, please check the following before seeking repair of service:

- Check if the power cord is plugged into an electrical outlet, if not plug in.
- Check if electricity to the main fuse is working.
- Make certain the power switches are turned on. If not, choose a setting.

Technical specification

- Power supply 220-240V 50 Hz
- Heater: Wattage max 1800w
- Insulation class I
- Height 110 cm

Maintenance and Care Instructions

- Only use the heater on a firm solid horizontal area where all the feet on the base are in contact with the floor. (Should the heater be tilted or fall over the auto cut off switch will activate)
- When disconnected from the electrical supply, clean the outside of the patio heater with a damp cloth. Never use corrosive or solvent cleaners or immerse in water.
- Any maintenance or repairs including replacing the halogen tube should only be carried out by a qualified electrician or by a qualified service centre.
- Although the patio heater is shower proof, do not use when raining or in wet conditions.
- Always disconnect the power cable from the electrical supply, when the patio heater is not in use.



For more information view our 'How-To' and maintenance videos: kettler.co.uk/how-to-guides



The symbol indicates that the product should not be discarded as unsorted waste but must be sent to separate collection facilities for recovery and recycling.

KETTLER

www.kettler.co.uk



PlanetMark



Warranty For Home Use

This product is covered by a 12 month warranty against manufacturing faults. This warranty applies to domestic use only. It does not cover commercial use, mis-use or accidental damage.

To validate your warranty, register at www.kettler.co.uk and quote the product code from the front of this booklet.