

KETTLER

Marina Corner Lounge Set - High/Low Table

009112-0400B1/B2



IMPORTANT

PLEASE KEEP THIS BOOKLET FOR FUTURE REFERENCE.
THIS IS IMPORTANT INFORMATION REGARDING THE
USE AND CARE OF YOUR GARDEN FURNITURE.



ASSEMBLY
TIME



PERSONS
REQUIRED

Assembly

Helpful advice before you begin:

1. We suggest you spend a short time reading through this leaflet and then follow the simple step by step instructions.
2. Do not discard any of the packaging until you have checked that you have all the parts and the pack of fittings.
3. Assemble this product on a soft surface.
4. To ensure an easier assembly, we strongly advise that all fittings are only finger tightened during initial assembly. Only upon completion of the assembly should all fixing points be fully tightened.
5. Keep fittings out of children's reach.
6. Do not use any other tools other than those recommended to build this product.
7. Please do not use substitute parts. Use only additional or replacement parts supplied by Kettler.
8. In the unlikely event that this product has missing or damaged parts, please visit our website www.kettler.co.uk

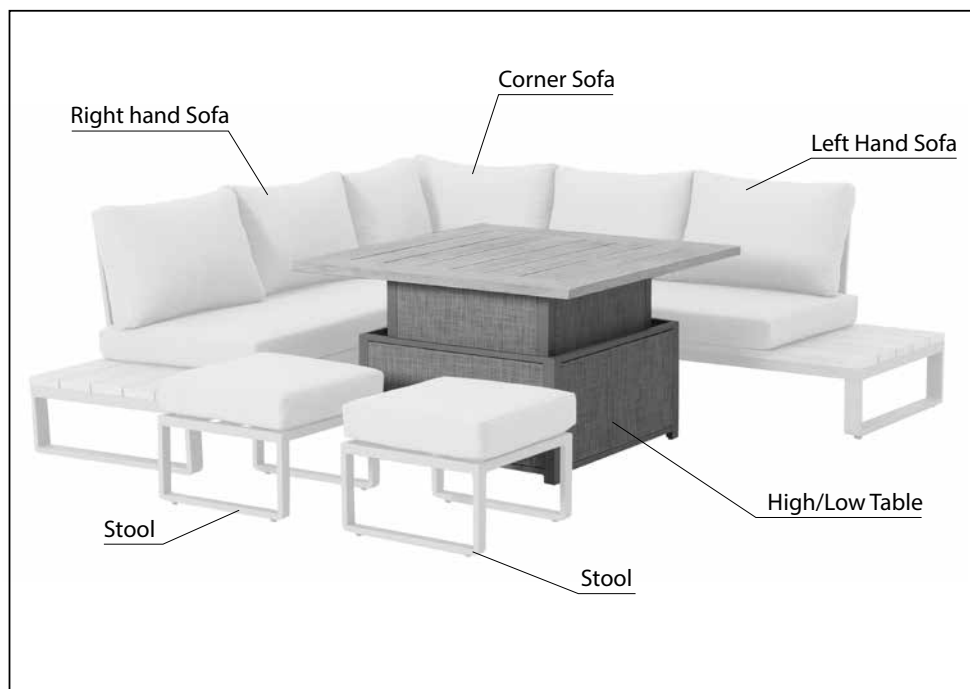

Parts List

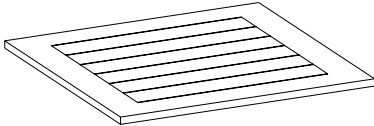

(A) Table Top

x1

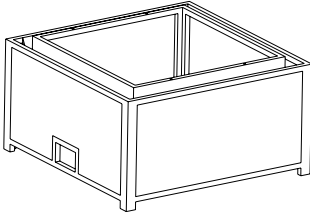

(B) Table Base

x1



(C) Washer

x4

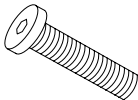

(D) Screw M6 x 35

x4



(E) Screw Caps

x4



(F) Allen Key

x1

Assembly



Assemble on a soft surface. Ensure this product is protected during assembly to avoid damage to the surface

1.

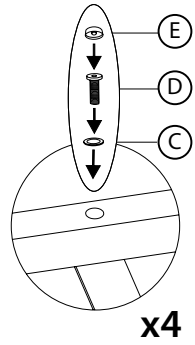
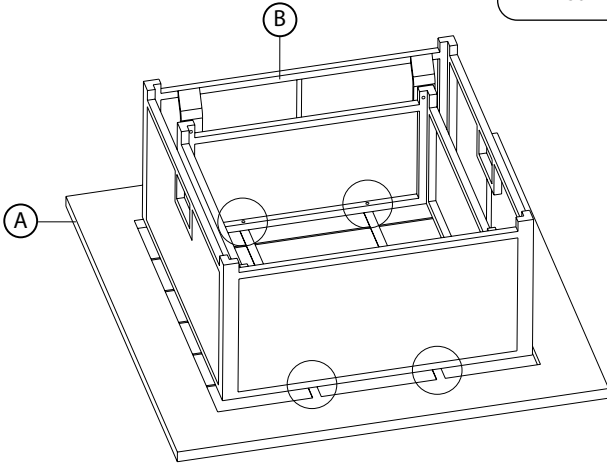

2.

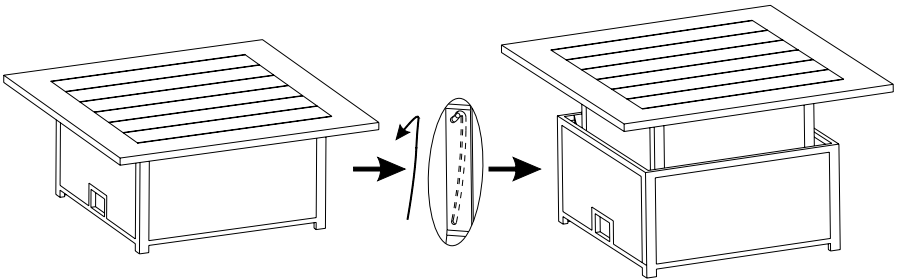

Finished.

High Low Table

2 people are required to change the height of the table

To raise to dining height:

Simply lift the table top (at an equal height at both ends) as far as you can, move forwards and lower slightly until it locks into place.

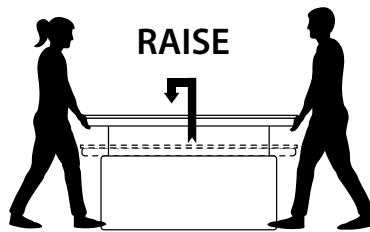

To lower to coffee table height:

Lift slightly (at an equal height at both ends), move backwards and lower to ground height until it locks into place.

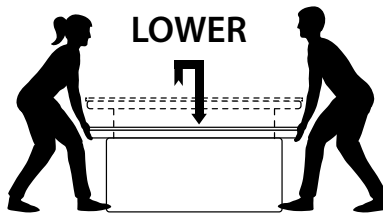

Helpful tips:

- Each person needs to put their foot into the recess at the either end of the table.
- The table needs to be clear when the table height is adjusted.

Maintenance and Care Instructions

- This product may only be used for its intended purpose for residential premises. Any other uses may affect the warranty.
- Kettler furniture is designed to be left outdoors all year round (excluding cushions).
- We recommend that you follow these simple tips and instructions to ensure it retains its good looks. Remove food and drink residue, tree sap and bird droppings as soon as possible to avoid staining. Marks should be removed using neat mild detergent with a soft cloth and washed off with water. Do not leave hot items directly on the table. Coasters will protect your table from heat and water rings. Do not drop anything sharp or heavy onto the table. Take care when placing items onto the table to avoid scratches.
- We recommend to maintain and lengthen the life of this product you follow the below regime:

On aluminium parts: We recommend the Kettler Multi-surface cleaner when necessary. The Kettler after-care range is available to purchase from the Kettler website.

- Moving parts such as locking mechanisms, catches and joints need to be lubricated where necessary.
- Kettler furniture can be covered. We recommend that you use Kettler tailored covers (where available) or fully breathable universal covers. Covers should not sit directly on the table top.
- This product is 100% recyclable. At the end of the products life, please dispose of responsibly.
- Colours may vary slightly.

Failure to comply with the outlined instructions will result in the warranty being invalidated.



For more information view our
'How-To' and maintenance videos:
kettler.co.uk/how-to-guides



Attention

Please be aware that painted/varnished surfaces can be damaged by sunscreens and oil based products. If the surface of your Kettler leisure furniture comes into contact with sunscreens, the surface is to be cleaned without delay as described above. Only in this way can lasting discolouration of the surface by the ingredients of the sunscreen be prevented.

For Your Safety

- This product may only be used for its intended purpose as furniture for residential properties.
- Check all components regularly for correct function, damage and loose connections especially at the start of the season and at 1-2 month intervals dependent on use.
- Damaged components may endanger your safety or shorten the life of the product. Replace all damaged parts immediately. Use only spare parts manufactured by Kettler. Should you wish to purchase spare parts, they can be ordered directly from: www.kettler.co.uk/shop
- Kettler will not be responsible for damaged caused by improper use.



Attention

- Whilst assembling this product keep out of the reach of children. (Choking hazard – contains small parts)
- Ensure that your working area is free of possible sources of danger, for example don't leave any tools lying around.
- Always dispose of packaging material in such a way that it may not cause any danger. There is always a risk of suffocation if children play with plastic bags!
- We reserve the right to make changes for technical reasons.

KETTLER

www.kettler.co.uk



PlanetMark



Warranty For Home Use

This product is covered by a 3 year warranty against manufacturing faults. This warranty applies to domestic use only. It does not cover commercial use, mis-use or accidental damage.

To validate your warranty, register at www.kettler.co.uk and quote the product code from the front of this booklet.